

FOREWORD

Thank you for your purchasing motorcycle.

This manual covers the main data, basic structure, and main procedures of operation, adjustment, maintenance and troubleshooting of motorcycle. It will help you familiarize yourself with all the necessary skills so that you will bring your vehicle into full, best play with minimized trouble for a long service life.

Products are always subject to further improvement, which will cause some difference between the vehicle and this manual, without further notice.

CONTENTS

| | | | |
|-------------------------------|----|---|----|
| VEHICLESAFERIDING | 1 | Check and Change of Engine Oil | 16 |
| Notes for Safety | 1 | Spark Plug | 17 |
| Protective Things | 2 | Air Cleaner | 18 |
| Refitting | 2 | Check Leaks along Air Supply Line | 18 |
| Accessories | 2 | Throttle Operation | 19 |
| SPECIFICATIONS | 3 | Idle Speed | 19 |
| DESCRIPTION | 4 | Inspection of Front suspension | 20 |
| Parts Location | 4 | Front Mechanical Drum Brake | 21 |
| VIN Record | 7 | Check of Brake System | 22 |
| Ignition Switch | 8 | Rear Hydraulic Disc Brake | 22 |
| Seat Lock | 8 | Brake Liquid | 22 |
| Fuel and Fuel Tank | 9 | Exhaust Muffler | 23 |
| Left Handlebar Controls | 10 | Battery | 24 |
| Safety Switch | 10 | Tool Kit | 25 |
| Speed-Limiting Device | 11 | Self-Recovered Overload Protector | 26 |
| Engine Oil | 11 | Trobleshooting | 26 |
| OPERATION GUIDE | 13 | Clearing | 26 |
| Pre-ride Inspection | 13 | Storage Guide | 27 |
| Starting the Engine | 13 | Removal from Storage | 28 |
| Breaking-in | 15 | MAINTERANCE | 29 |
| Riding | 15 | Maintenance Schedule | 29 |
| parking | 16 | ELECTRIC DEAGRAM | 30 |

VEHICLE SAFE RIDING

WARNING

Vehicle riding requires special efforts on your part to ensure your safety. Know these requirements below before you ride.

NOTES FOR SAFETY

1. Both parents and their children must fully understand everything in this Owner's Manual before riding.
2. This vehicle is for OPERATOR ONLY.
3. For OFF-ROAD USE ONLY. This vehicle is designed to be operated only on level, off-road surface, free of obstacles.
4. It is illegal to ride this vehicle on public roads or highways. If it is necessary to cross a public road, please get off this vehicle and push it across.
5. Do not operate this vehicle while under the influence of alcohol or drugs. That can impair judgment and result in serious injury or even death.
6. Keep a safe distance between your vehicle and other off-road vehicle.
7. Never ride this vehicle unless it has been properly adjusted and maintained.
8. Do not allow your child to ride without your supervision.
9. Never run the engine in closed area. The exhaust gas contains poisonous carbon monoxide gas (CO).
10. Don't touch any part of the engine and muffler during and even after riding, because it is very hot.

PROTECTIVE THINGS

1. Most motorcycle accident fatalities are due to head injuries. ALWAYS wear a helmet. You should also wear a face shield and protective clothing.
2. The exhaust system becomes hot during riding, and it remains hot for a while after stopping the engine. Be careful not to touch the exhaust system since it is hot. Wear clothing that fully covers your legs.
3. Do not wear loose clothing that could catch on the control levers, kick-starter, footrests or wheels.

REFITTING

WARNING

Refitting of the motorcycle, or removal of original parts may make the vehicle unsafe or illegal. Obey all national and local equipment regulations.

ACCESSORIES

Genuine accessories by our Co. have been specifically designed and tested on the motorcycle. Because our Company won't test accessories manufactured by other companies, you are personally responsible for selection, installation, and use of them. Always follow the guidelines below:

1. Carefully inspect the accessory to make sure that it does not obscure any lights, reduce ground clearance and banking angle, or limit suspension travel, steering travel or control operation.
2. Accessories may increase the time that hands or feet operate controls, resulting in increased reaction time in an emergency.
3. Do not add electrical equipment that will exceed the vehicle's electrical system capacity.
4. Do not add device cooling the engine.

MAIN DATA

| | | | | | |
|---------------------------|--------------------|-------|-------------------------------|---------------------------|---------------------------|
| Overall length | 1470mm | | Climbability | $\geq 30^\circ$ | |
| Overall width | 900mm | | Cylinder bore \times stroke | 61.0 \times 49.5mm | 63.5 \times 62.2mm |
| Overall height | 990mm | | Compression ratio | 9.2: 1 | 9.0: 1 |
| Wheelbase | 1010mm | | Output,max. | 8.0kW/9000r/min | 11.5kW/8500r/min |
| Dead weight | 160kg | | Torque,max | 10.0N \cdot m/7500r/min | 15.0N \cdot m/7000r/min |
| Payload | 150kg | | Idling speed | 1500r/min | |
| Front wheel | 19 \times 7-8 | | Displacement of cylinder | 145.0ml | 196.9ml |
| Rear wheel | 18 \times 9.50-8 | | Spark plug | D8TC | |
| Speed, Max | ≥ 60 km/h | | Spark plug gap | 0.6-0.7mm | |
| Brake distance(30km/h) | ≤ 7 m | | Cap of air Valve | 0.06mm | |
| Lubricating oil | 1.1L | | | 0.08mm | |
| Capacity of gasoline tank | 6.6L | | Battery | 12V7Ah | |
| Transmission ratio | | | Ignition means | CDI | |
| 1st gear | 2.769 | 2.545 | 2nd gear | 1.882 | 1.688 |
| 3rd gear | 1.400 | 1.280 | 4th gear | 1.130 | 1.042 |
| 5th gear | 0.960 | 0.903 | 6th gear | | 0.815 |
| Final reduction | 3.333 | | Ground clearance | 180 | |

DESCRIPTION

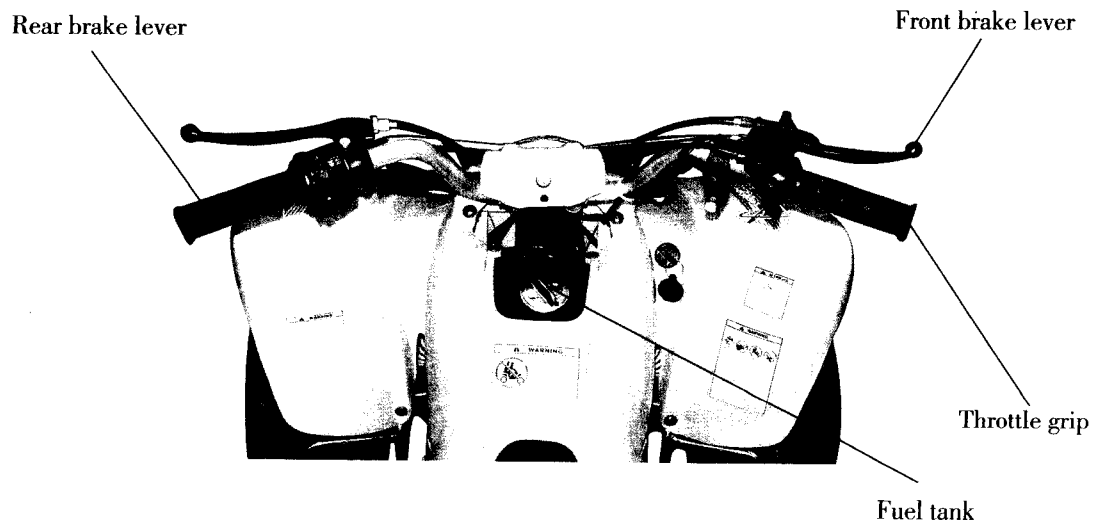

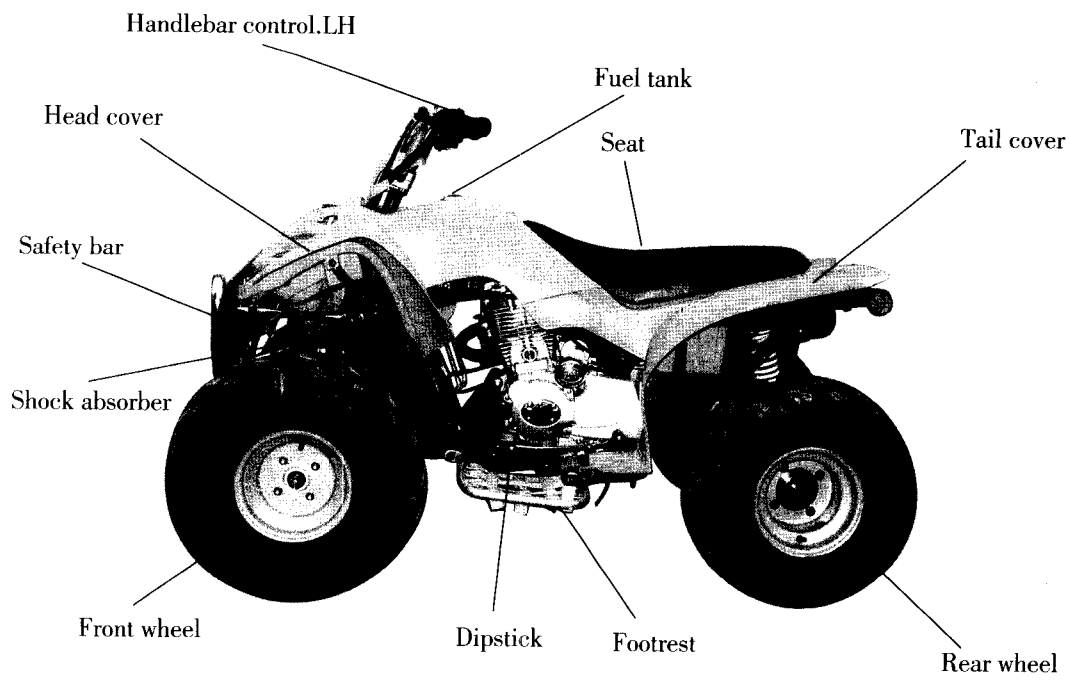

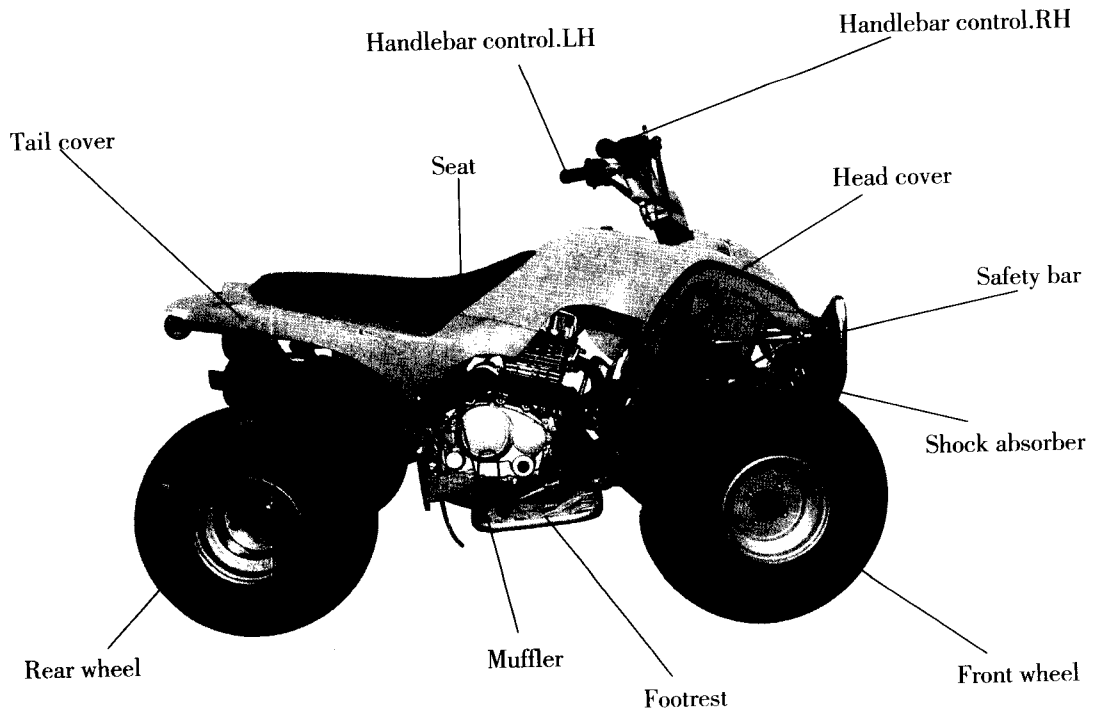

VIN RECORD

Please fill the VIN and engine code of your motorcycle in blank below. They will help order spare parts and find out the vehicle once stolen.

①VIN ②Nameplate

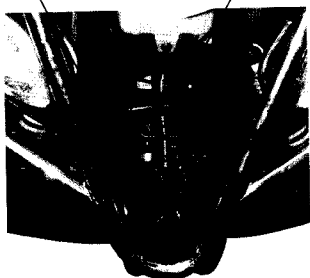

③Engine code

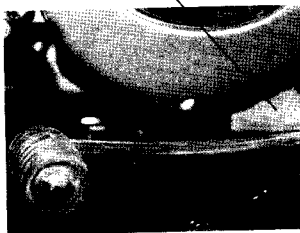

VIN: ☆ ☆

Engine code: ☆ ☆

NOTES

- ①The VIN is stamped on the front transversal beam.
- ②The vehicle nameplate is fixed on the upper support of the front frame.
- ③The engine code is stamped on the bottom-left of the crankcase.

IGNITION SWITCH

The ignition switch is situated on the front right of the vehicle body.

“⊗” (OFF) and “○” (ON) on the switch indicate:

⊗ (OFF): Engine and lights cannot be operated and the key can be removed.

○ (ON): Engine and lights can be operated and the key cannot be removed.

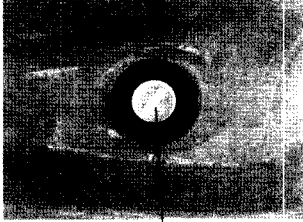

Ignition switch

SEAT LOCK

The seat lock is set below the cushion. Pull backward the seat lock rope, the seat will spring out of its support; to lock the seat, put it down and depress downwards.

Seat Lock

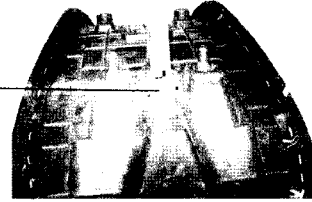

FUEL AND FUEL TANK

Fuel Selection

Fuel is a key factor in deciding the exhaust emissions amount from the engine, so selection of fuel must follow the rules below.

Selected fuel must be unleaded or low-lead gasoline with No. RQ-90 or higher.

Fuel Tank

The fuel tank capacity is 4L.

WARNING

- Gasoline is extremely flammable and is explosive under certain conditions. Refuel in a well-ventilated area with the engine stopped. Do not smoke or allow flames or sparks in the area where gasoline is stored or where the fuel tank is refueled.
- Before refueling, make sure to filter fuel first.
- Be careful not to spill fuel when refueling. Spilled fuel or fuel vapor may ignite. If any fuel is spilled, make sure the area is dry before starting the engine.
- Avoid repeated or prolonged contact with skin or breathing of vapor.
- KEEP OUT OF REACH OF CHILDREN.

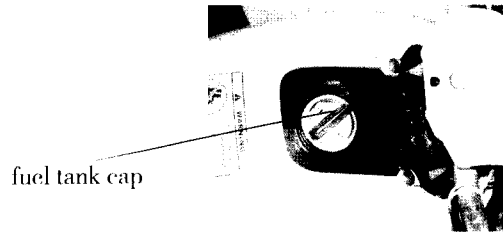

LEFT HANDLEBAR CONTROLS

Emergency Switch

In normal, the switch is set in middle position; to stop the engine, set the switch to left or to right.

Parking button

When stoping the vehicle, depress it to lock the rear wheel; restarting the vehicle, pull in the rear brake lever to spring it up.

Starter Button

Press the button With the vehicle in braking to start up the engine.

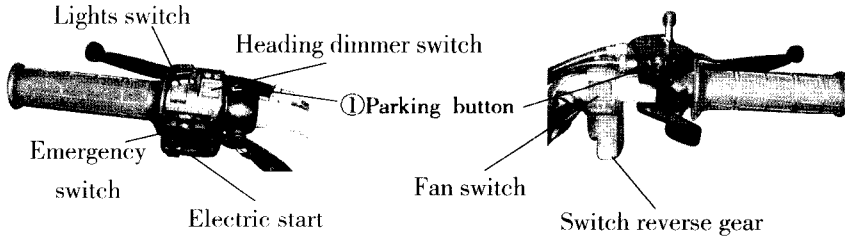

SAFETY SWITCH

Pull off the safety switch cap, the engine stops.

WARNING

Never tie the safety switch wire to the rider. In an emergency, the supervisor should pull the safety switch wire from behind the vehicle to activate the safety switch so as to stop the engine immediately.



safety switch

SPEED-LIMITING DEVICE

Turn loose the lock nut and screw in the adjusting screw, at last, tighten the locknut.

CAUTION

It's better for inexperienced riders to set the top speed lower so as to avoid accidents.

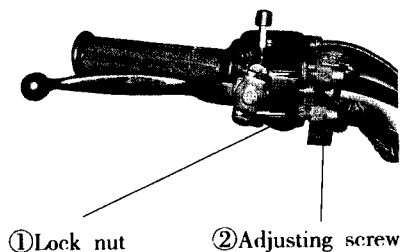

ENGINE OIL

The quality of the engine oil plays a vital role in deciding the engine performance and service life. Engine oil must be selected in accordance with the rules below and other oils, are

forbidden to be used.

Engine oil recommended: gasoline engine oil Class SAE15W/40-SE or Class SE, SF, SC from API Service Classification.

The vehicle has been filled with the engine oil Class SAE 15W/40-SE class before being delivered, and the lubricant is only suitable at a temperature range from +40°C to -10°C. If other motor oil is to be used instead, the alternative must be technically equivalent in every respect. Viscosity varies with regions and temperatures, so the lubricant has to be selected according to our recommendation. If the gasoline engine oil Class SAE15W/40-SE can not be obtained when in need, the gasoline engine oil No. HQB-10 (or No. HQB-6 in regions where the temperature is under -10°C) is available.

Before replacing the lubricant, please drain the oil out completely remaining in the crankcase, and clean the inside by clean kerosene, then fill new one instead.

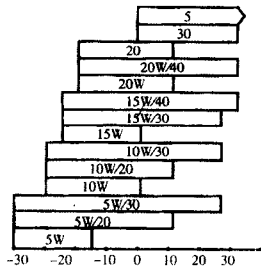

CAUTION

Running the engine with insufficient oil can cause serious damage to engine.

TYRES

Proper air pressure will provide maximum stability, riding comfort and tyre life.

Check tyre pressure frequently and adjust if necessary.

Select the right replacement tyres in accordance with the specifications shown in the table 1.

| Pressure (kPa) | Front: 100 | Rear: 100 |
|------------------|---------------|-----------|
| Tyre size | Front: 19×7-8 | 18×9.5-8 |

NOTE

Tyre pressure should be checked before you ride while the tyres are cold. Check the tyres for cuts, embedded nails, or other sharp objects.

Check the rims for dents or deformation. See your dealer for change of damaged tyres or punctured inner tubes.

WARNING

- Do not attempt to patch a damaged tyre or inner tube, otherwise wheel balance and tyre reliability may be impaired.

- Improper tyre inflation will cause abnormal tread wear and create a safety hazard. The tyre pressure less than the rated value may result in the tyre slipping on the ground, or coming off from the rim, even the vehicle being out of control.

- Operation with excessively worn tyres is hazardous and will adversely affect traction and handling.

- The use of tyres other than those listed on the

table 1 may adversely affect handling.

When the tread depth in the middle section of tyres reaches the limits in table 2 below, please replace tyres.

| Tread depth limits | |
|--------------------|-----------------|
| Front tyre 2.0mm | Rear tyre 2.0mm |

OPERATION GUIDE

PRE-RIDE INSPECTION

WARNING

If the Pre-ride Inspection is not performed, severe injury to personnel or damage to equipment may occur.

Inspect your motorcycle every day before you ride it. The items listed here will only take a few minutes to inspect, and in the long run they can save time, expense, and your life.

1. Engine oil level – add engine oil if required. Check for leaks
2. Fuel level – fill fuel tank when necessary. Check for leaks.

3. Front and rear brakes – check operation and if necessary, adjust free play.

4. Tyres – check condition and pressure.

5. Throttle operation – check for smooth opening and full closing in all steering positions; check for throttle grip free play and throttle cable in lubricating and connecting.

6. Fastener – check that all nuts, screws and bolts are fixed securely.

7. Steering system – check for its smoothness and reliability. Correct any discrepancy before you ride. Contact your dealer for assistance if you cannot correct the problem.

STARTING THE ENGINE

Always follow the proper starting procedure described below.

WARNING

Never run the engine in an enclosed area. The exhaust emissions contain poisonous carbon monoxide (CO) gas that can cause loss of consciousness and lead to death.

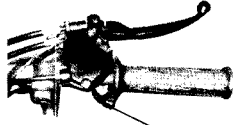
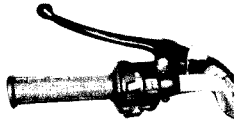

Throttle grip



Ignition switch



Kick-starter

★ Starting procedure by the starter button 1. Place the vehicle on a level ground and lock the rear brake by depressing down the parking button.

2. Insert the ignition key into the ignition switch and turn to (ON).

3. Set the emergency switch to "ON".

4. Depress the starter button while rotate the throttle grip slightly to start the engine. Release the starter button once the engine starts.

NOTE

Do not use the electric starter for more than 5 seconds at a time. Release the starter button for approximately 10 seconds before pressing it again. 5. When starting and warming up the engine, make sure to maintain the throttle slightly open.

6. Before riding the vehicle, make sure that the engine is well warmed up.

CAUTION

Opening or closing the throttle fully and rapidly may make the vehicle's sudden moving forwards, resulting in out of control.

★ Starting procedure by the kick-starter

1. Do as 1-2 steps under "Starting procedure by the starter button".

2. The throttle being slightly open, tread down the kick-starter in a rapid and continuous way.

CAUTION

● It is forbidden to let the kick-starter strike against the pedal stop, otherwise, the engine case may be damaged. You may also start the engine by the starter button.

●Lift up the starting bar after the kick-starter returns to the pedal stop.

3.Do as 5-6 steps under Starting procedure by the starter button.

BREAKING-IN

Help assure your vehicle's future reliability and performance by paying extra attention to how you ride during the first two-week riding.

During this period, avoid full-throttle riding and loading the engine heavily; be sure to keep changing speed.

NOTE

After the breaking-in period, be sure to conduct maintenance according to the maintenance schedule so as to keep the vehicle in a sound condition, which will extend the service life of the engine obviously.

RIDING

WARNING

Review, Vehicle Safe Riding, before you ride.

1. After the engine has been warmed up, the vehicle is ready for riding.

2. End braking state of the vehicle.

CAUTION

Riding with only one hand may cause the vehicle out of control.

3. Open the throttle gradually so the vehicle moves forward.

4. To speed down the vehicle, reduce the throttle while carry out braking. Coordinate the throttle with brakes for smooth deceleration.

NOTE

Both the front and rear brakes should be used at the same time and should not be applied strongly enough to lock the wheel, or braking effectiveness will be reduced and control of the vehicle be difficult.

PARKING

1. Close the throttle while apply the brakes to speed down the vehicle until it stops.
2. Turn the ignition key to (OFF), and remove the key once the engine stops.
3. Depress down the parking button at the left handlebar.

CHECK AND CHANGE OF ENGINE OIL

Check of Engine Oil Level

Check the engine oil level each day before riding the vehicle.

The level must be maintained between the upper and lower level marks on the dipstick.

1. Start the engine and let it idle for a few minutes.
2. Stop the engine and put the vehicle on a level ground.
3. After a few minutes, remove the oil filler cap/dipstick, wipe it clean, and reinsert the dipstick without screwing it in, remove the dipstick. The oil level should be between the upper and lower level marks on the dipstick.

16

Change of Engine Oil

The engine oil quality is the chief factor affecting the engine service life. Change the engine oil as specified in the maintenance schedule.

1. Drain out the engine oil in the crankcase completely.
2. Clean the crankcase inside with cleaning solvent.
3. Add specified engine oil about 0.8L.

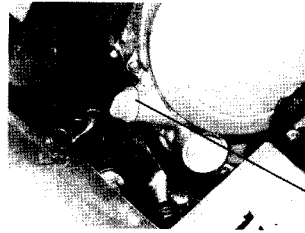

③ Oil filler cap/Dipstick

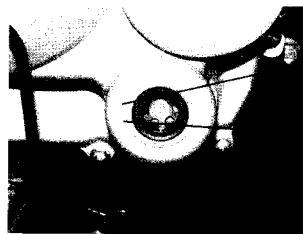

① Upper level mark

② Lower level mark

CAUTION

Running the engine with insufficient oil would cause serious damage to the engine.

When running in very dusty conditions, oil changes should be performed more frequently than specified in the maintenance schedule.

Please dispose of used engine oil in a manner that is compatible with the environment. We suggest you take it in a sealed container to your local recycling center or service station for reclamation. Do not throw it in the rubbish or pour it on the ground or down a drain.

SPARK PLUG

Selection

Plug recommended: C7HSA NGK

Check and Replace

1. Disconnect the spark plug cap from the spark plug.
 2. Clean any dirt from around the spark plug base.
- Remove the spark plug using the plug wrench containing in the tool kit.

3. Inspect the electrodes and center porcelain for deposits, erosion or carbon fouling. If the erosion or deposit is heavy, replace the plug. Clean a carbon or wet-fouled plug with a plug cleaner, or use a wire brush.

4. Check the spark plug gap using a wire-type feeler gauge. If adjustment is necessary, bend the side electrode carefully.

The spark plug gap should be 0.6–0.8mm.

Make sure the plug washer is in good condition.

5. With the plug washer attached, thread the spark plug in by hand first to prevent cross threading, and then tighten up it by the spark plug wrench.

6. Reinstall the spark plug cap.

- ① Side electrode
- ② Center electrode

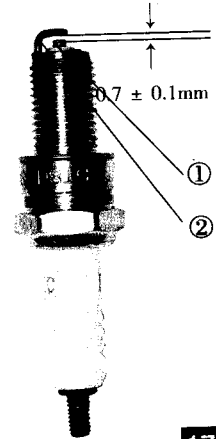

AIR CLEANER

The air cleaner should be serviced at least once every 30-day's drive. Service more frequently when riding in unusually wet or dusty areas. See your dealer for further information.

1. Remove the air cleaner from the frame.
2. Disassemble it and take out filter element.
3. Wash the filter element in clean, nonflammable or high flash point solvent and let it dry.

WARNING

Never use gasoline or low flash point solvents for cleaning the filter element, otherwise, a fire or explosion could result.

4. Soak it in gasoline engine oil Class 15W/40QE until saturated, and then squeeze out the excess oil.
5. Clean the inside and outside of the air cleaner housing.
6. Install the removed parts in the reverse order of removal.

CAUTION

- It is forbidden to start the engine without the air cleaner core, or premature wear of the piston and cylinder may produce.
- Make sure the air cleaner core is intact.
- Prevent the air cleaner core from getting water when washing the vehicle.

CHECK LEAKS ALONG AIR SUPPLY LINE

Check leaks regularly along air supply line, and repair or replace related parts once there are some to assure a normal air supply.

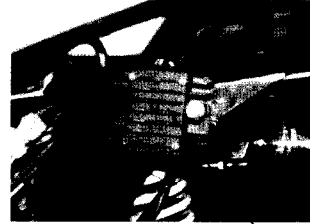

Filter element

THROTTLE OPERATION

1. Check for smooth rotation of the throttle lever from the fully open to the fully closed position at both full steering positions.

2. Measure the throttle lever free play at the throttle lever flange.

The standard free play should be within 2–6mm.

To adjust the free play, loosen the lock nut and turn the adjust.

IDLE SPEED

The engine must be at normal operating temperature for accurate idle speed adjustment.

NOTE

Do not attempt to compensate for fault in other systems by adjusting idle speed. See your dealer for regularly carburetor adjustments.

1. Warm up the engine.

2. Connect a tachometer to the engine (a remote-controlled one can be used).

Turn the throttle stop screw clockwise (in the direction of the arrowhead A) will increase idle speed while will decrease it turning counterclockwise (in the direction of the arrowhead B).

3. When the engine has no idle speed or runs at a decreased speed, set the throttle stop screw in the middle between the two limit position to help mix air and fuel.

4. Run the engine again; readjust the throttle stop screw if necessary.

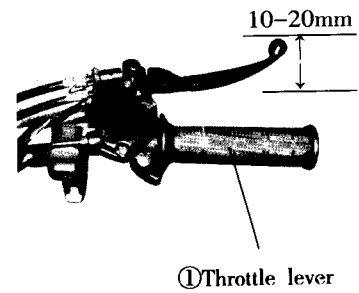

CAUTION

Since the carburetor is a precision apparatus, don't disassemble it without the professional knowledge.

WARNING

The balance pipe of carburetor should be often checked to make sure there is no dust or other impurity inside it, otherwise, an accident may occur.

INSPECTION OF FRONT SUSPENSION

1. Check the front fork assembly by locking the front brake and pumping the fork up and down vigorously, Suspension action should be smooth.
2. Check the front shock absorber for oil leaks and deformation.
3. Carefully inspect front suspension fasteners for tightness.

CAUTION

Before checking, support the vehicle firmly to prevent it from falling over.
Should defect be detected on front fork, replace or repair it.

Throttle stop screw

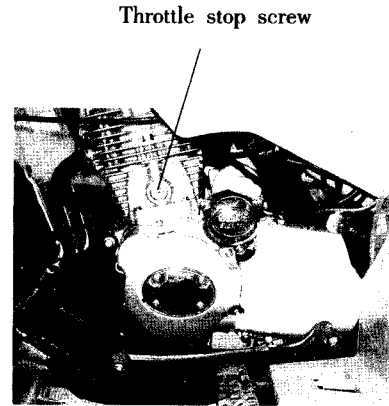

FRONT MECHANICAL DRUM BRAKE

The distance the front brake lever moves before the brake starts to engage is called free play.

Measured at the tip of the front brake lever, free play should be within 10–20mm.

1. Adjustment should be made using the adjusting bolt at the right handlebar.

2. Apply the brake several times and check for free wheel rotation when release the brake lever.

One should bear in mind, that the front brake lever, brake arm and fasteners are in a sound condition.

NOTES

● Make sure the curved slot in the adjusting nut is seated on the brake arm pin after making final free play adjustment.

● If such adjustment is still unsatisfactory, see your dealer for help.

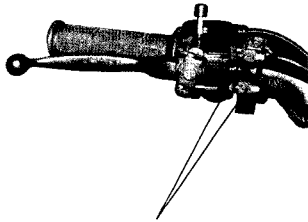

① Adjusting bolt

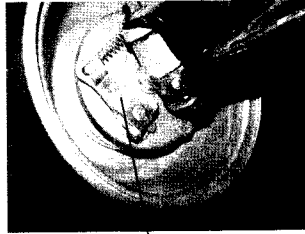

② Front brake

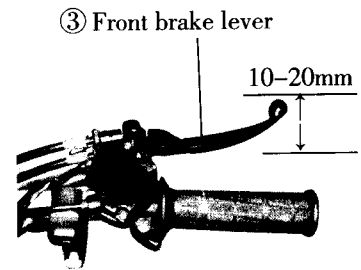

③ Front brake lever

CHECK OF BRAKE SYSTEM

The brake system should be checked every day before you ride the vehicle.

1. Check the brake main cylinder for proper oil level.
2. Check to see there is no leakage from the system.
3. Check the brake hose and main cylinder for cracks.
4. Check the brake disc for wear.
5. Check the brake lever for proper free play.

CAUTION

The hydraulic disc brake is designed to operate under high pressure.

For the sake of safety and reliability, the service life of brake hose, main cylinder and brake liquid must not be beyond the limit specified in the manual.

If the hydraulic disc brake system needs to be maintained or repaired, conduct the problem by your dealer only.

If you feel soft when operating the brake lever, it means there is air inside the brake system. In this

case, air should be discharged from the brake system before riding the vehicle, otherwise, the brake feature will drop considerably, even cause an accident. For which purpose, see the your dealer.

Brake main cylinder

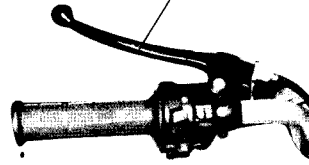

REAR HYDRAULIC DISC BRAKE

The motorcycle is equipped with a set of single-cylinder disc brake.

BRAKELIQUID

Be care to check the brake liquid in the main cylinder located on the right handlebar for proper level, and add the specified liquid if

necessary. As the brake pads wear, the brake liquid level drops. The brake should be inspected periodically.

WARNING

● Brake liquid is a strong irritant. Avoid contact with skin or eye. In case of contact, flush thoroughly with water and call a doctor if your eye were exposed.

● Keep out of reach of children.

Brake liquid used for the brake system is non-petroleum brake oil No. 4604. Never mix with other oil such as silicon oil, or serious damage to the brake system may occur.

CAUTION

● It is forbidden to use the used liquid or the liquid placed in the open container.

● Never use the liquid which has been stored for long time, because it contains moisture inhaled from air.

● Handle brake liquid with care because it can damage plastic and painted surface.

EXHAUST MUFFLER

Clear away regularly carbon deposit in the exhaust pipe; check the exhaust pipe inside for crack and washer damage, and repair or replace if necessary.

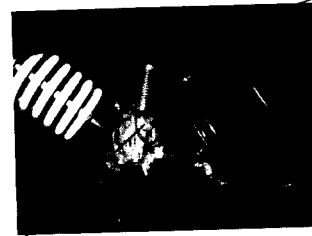

Brake disc

Brake caliper with pads

BATTERY

Battery electrolyte is poisonous, so be sure not to discard it at will. Handle in accordance with national or local enational or local environmental protection rules.

Check

The battery electrolyte level should be between the UPPER level mark and the LOWER level mark. If battery electrolyte level is below the LOWER level mark, add proper distilled water to the UPPER level mark.

CAUTION

Before handing the vehicle over for long-term storage, remove the battery from the vehicle and charge it fully, and then store it in a cool, dry place. If the battery is to be left in the motorcycle, disconnect the negative lead (-) from the battery terminal first and then the positive lead (+). Do not touch the positive and negative leads with metal objects to prevent short-circuiting during the operation above.

WARNING

● The battery gives off explosive gases; keep sparks, flames, and cigarettes away. Provide adequate ventilation when charging or using the battery in an enclosed space.

● The battery contains sulfuric acid (electrolyte). Contacting with skin or eyes may cause severe burns. Wear protective clothing and a face shield.

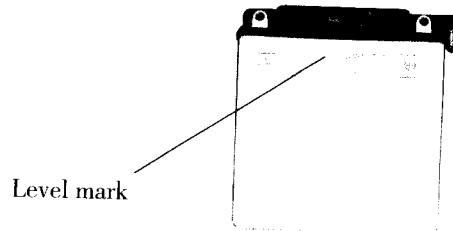

If electrolyte gets in your skin, flush with water.

If electrolyte gets in your eyes, flush with water for at least 15 minutes and call a physician immediately.

● Electrolyte is poisonous. If swallowed, drink large quantities of water or milk and follow with milk of magnesia or vegetable oil and call a physician.

● KEEP OUT OF REACH OF CHILDREN Dismantle, reveal the battery box cover. 2. Disconnect the negative lead from the battery first, and then the positive lead.

3. Take out the battery from the battery box.

① Battery box cover ② Screw ③ Negative lead ④ Battery ⑤ Protector ⑥ Positive lead

TOOL KIT
Some roadside repairs, minor adjustments and parts replacement can be performed with the tools contained in the kit.

① Opened-end spanner, 8×10mm ② Double-end screw driver ③ Open-ended spanner 12×14mm ④ Screw driver handle ⑤ Spark plug wrench ⑥ Tool bag

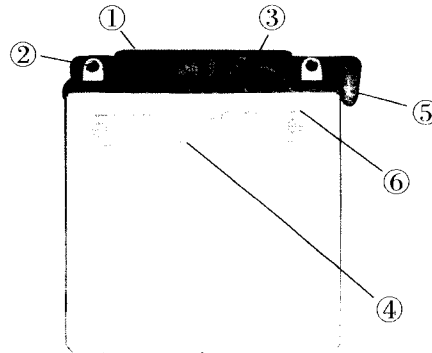

SELF-RECOVERED OVERLOAD PROTECTOR

The vehicle is equipped with a self-recovered overload protector, The protector will cut off the circuit automatically in the case of troubles such as a short circuit or an overload trouble, and it will switch on the circuit automatically a few seconds after you turn on the power switch in the case of troubleshooting.

TROUBLESHOOTING

If the vehicle has some trouble, see your dealer for help.

CAUTION

Do not dismantle or maintain the vehicle without the professional knowledge.

CLEANING

Clean your vehicle regularly to protect the surface finish and inspect for damage, wear, and oil or brake fluid leakage.

CAUTION

High-pressure water (or air) can damage certain parts of the motorcycle.

Avoid spraying high-pressure water at the following areas: Wheel Hubs; Ignition Switch; Carburetor; Handlebar Controls; Muffler Outlets; Under Fuel Tank; drive chain; Under Seat

1. Wash the vehicle completely with a great deal of water.

2. Dry up the vehicle, start the engine, and let it run for several minutes.

WARNING

Braking efficiency may be temporarily impaired just after washing the motorcycle. Anticipate longer stopping distance to avoid a possible accident.

3. Test the brakes before riding the vehicle. Several applications may be necessary to restore normal braking performance.

4. Lubricate the drive chain immediately after washing and drying the motorcycle.

STORAGE GUIDE

Some measures should be taken when the vehicle is subjected to a long term storage so as to reduce the bad influence on its performance. Before the storage, make necessary maintenance to ensure the vehicle high performance after-storage.

Storage

1. Clean and dry up the vehicle and wax its surface.

2. Empty the fuel from the fuel tank and carburetor, spray some antirust.

WARNING

Gasoline is extremely flammable and is explosive under certain conditions. Perform this operation in a well-ventilated area with the engine stopped. Do not smoke or allow flames or sparks in the area where gasoline is drained or stored and where the fuel tank is refueled.

3. Drive off the spark plug to fill a little of engine oil (about 15-20 millilitre) into the cylinder; turn off the ignition switch and tread the kick-starter several times to scatter evenly the oil inside the cylinder, and then

reinstall the spark plug.

4.Clean and oil the drive chain.

5.Lubricate all the cables.

CAUTION

When removing the battery,dismantle the negative lead first,and then the positive lead.When installing it,the procedure is just opposite.During the operations above,the ignition switch must be turned off.

6.Seal the muffler outlet with plastics cloth to protect the former from moisture.

7.Cover the vehicle(don' t use plastics or other coated materials)and store in an unheated area,free of dampness.

Do not store the vehicle in direct sunlight.

REMOVAL FROM STORAGE

1.Take off the cover shielding the vehicle and clean it.

2.Charge the battery as required.Install the battery.

3.Clear away the antirust inside the fuel tank,and fill fresh gasoline instead.

4.Perform al Pre-ride Inspection checks.Trythe vehicle at low speeds in a safe riding area away from traffic.

MANTENANCE

The Maintenance Schedule specifies how often you should have your motorcycle served, and what things need attention. It is essential that your motorcycle be served as scheduled to retain its high level of safety, dependability, and emission control performance.

MAINTENANCE SCHEDULE

The following Maintenance Schedule specifies all maintenance required under normal conditions to keep your vehicle in sound condition. Riding under unusually dusty or wet conditions, service of the vehicle should be made more often than the specified in the schedule. Maintenance work should be performed by properly trained and equipped technicians.

I; INSPECT AND CLEAN, ADJUST, LUBRICATE OR REPLACE IF NECESSARY C; CLEAN

I; LUBRICATE

| | First week | Every 30-day's ride | Every year |
|----------------------------|------------|---------------------|------------|
| Fuel system | I | | |
| Operation of throttle | | I | |
| Air cleaner | | C | |
| Spark plug | | I | |
| Idle speed of carburetor | I | I | |
| Drive chain | I&L | I&L | |
| Brake shoe wear | | | |
| Brake system | I | I | I |
| Nuts, bolts, and fasteners | I | I | |
| Wheel | I | I | I |
| Steering system | | | I |
| Suspension system | | I | I |

ELECTRIC DIAGRAM

